

AIWA®

S/M Code No. 84-025

DATE OF ISSUE 9/1984

SERVICE MANUAL

**STEREO CASSETTE
DECK**

MODEL NO.

AD-R450

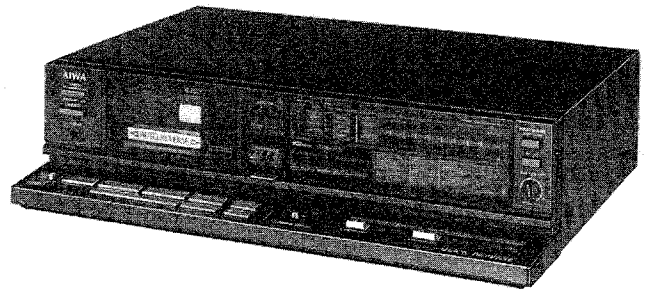

TYPE. HB, HUB, HJB, CB, EB, KB, GB, Z

SPECIFICATIONS

Type	Stereo cassette tape deck		Recording system	AC bias (frequency 85 kHz)
Track format	4 tracks 2 channels		Erase system	AC erase
Power supply	AD-R450 E, Z	AC 220 V, 50/60 Hz	Motor	DC Servomotor × 1, DC Motor × 1
	AD-R450 K, G	AC 240 V, 50/60 Hz	Head	DX head
	AD-R450 U, C	AC 120 V, 60 Hz	Inputs	LINE IN maximum input sensitivity: 50 mV (over 50 kΩ) DIN max sensitivity (Z model only): 0.1 mV/kΩ (3.3 kΩ)
	AD-R450 H, HU, HJ	AC 120 V/220 V-240 V switchable, 50/60 Hz	Outputs	LINE OUT standard output level: 0.4 V (0 VU); suitable load impedance: over 50 kΩ; DIN standard level (Z model only): 0.4 V (0 VU) Headphones: 8-32 Ω
Power consumption	15 W		Dimensions	420(W) × 110(H) × 300(D) mm
Frequency response	METAL tape:	20-18,000 Hz	Weight	4.4 kg
	CrO₂ position tape:	20-17,000 Hz	Accessories	Stereo pin cord (2)
	NORMAL tape:	20-16,000 Hz		
Signal-to-noise ratio	73 dB (METAL tape DOLBY C NR ON)			
Wow and flutter	According to DIN 45 500 0.1%			
	0.04% (WRMS)			
Tape speed	4.8 cm/sec. (1-7/8 ips)			
Rewind time	70 sec. (C-60)			
Fast forward time	70 sec. (C-60)			

- Design and specifications are subject to change without notice.
- Noise reduction system manufactured under license from Dolby Laboratories Licensing Corporation.
- Dolby and the  symbol are trademarks of Dolby laboratories licensing corporation.

Follow the instructions carefully, which will allow the user to optimise the products' performance and give many years of service.

1. No scratch and melting shall be made to covered lead-wires of an a.c. primary circuit including mains leads.
2. No illegibility shall be given to the specification plate, the caution labels, the fuse labels and others.
3. When, on pattern sides of circuit boards, additional repair-parts have been made up, the parts shall be firmly glued to circuit boards or other components, unless the parts can be attached firmly.
4. The following matters shall be maintained as they are, when repairing.
 - 1) Soldering of lead-wire ends
 - * Care should be taken of the space distance in an a.c. primary circuit as well as soldering.
 - 2) Wiring and holding of lead-wires with wire-clips and binders
 - 3) Materials of lead-wires
 - * e.g.; For UL models, lead-wires to be used shall be approved or accepted by the UL.
 - 4) Location of all kinds of insulators
 - 5) Setting of voltage selector switch
 - * Set the Voltage Selector Switch to 240V, 220V, or 120V, According to your Local Voltage.
5. After repaired, the insulation resistance or leakage current shall be measured with $500 \pm 5V$ D.C and shall be not less than $1M\Omega$.

Measuring Point

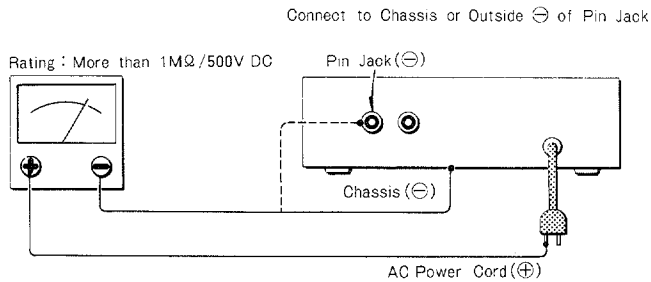

6. General instructions for mechanism repair

- 1) The heads, capstan and pinch roller shall be cleaned of good quality alcohol after repaired, because dirty heads shall cause distorted sounds while dirty capstan and pinch roller shall occur wow/flutter and take-up fault.
- 2) When oiling, only one or two drops shall be applied so as not to run over and be dispersed. Note should be taken of the metal fitting for the capstan and rotating portions of the idlers and pinch roller, especially.
- 3) E-rings and poly slider washers shall be replaced with new ones, if once those have been removed. — No re-utilization due to unreliability.
- 4) Regular spare-parts shall always be used for repair, because using irregular parts and tampering with the products shall cause deterioration, malfunction and damage.

ELECTRICAL MAIN PART LIST

• ★-mark means less required items and availabilities may be limited.

Symbol No.	Part No.	Description
< I C >		
	87-027-879	AN6882
	87-020-260	BA12003
	87-020-261	LA6358S
⊕	82-197-641	LC6502B-639
	87-020-140	L78M12
	87-027-895	M5218L
	87-927-986	NJM4560S
⊕	87-027-937	TC4030BP
< TRANSISTOR >		
	82-109-521	2SA952K
	89-110-155	2SA1015GR
	89-309-457	2SC945LK
	89-318-156	2SC1815BL
	89-318-155	2SC1815GR
	89-322-406	2SC2240BL
	89-328-785	2SC2878A, B
	89-408-805	2SD880GR
	89-413-023	2SD1302S, T
< MAIN CIRCUIT BOARD SECTION >		
PCB-A	*	MAIN CIRCUIT BOARD
D411.412.	87-027-097	DIODE, 1S1555
413.414.		
701.702.		
703.705		
D601.602.	82-596-799	DIODE, IN4002 (H, HU, HJ, C, U only)
603.604.		
706		
D601.602.	87-027-083	DIODE, 1S1885 (E, K, G, Z only)
603.604		
D704	87-020-123	DIODE, DS446
L351.352	82-135-631	TRAP COIL, 85K
L353.354	87-003-109	COIL, 5.6mH
L401	82-194-632	BIAS OSC COIL, 85K
L501.502	82-135-632	MPX FILTER, 85K
L701	82-196-649	OSC COIL, LC6502
S501	87-031-788	PUSH SWITCH (DOLBY B-C NR ON/OFF)
S502	87-031-787	PUSH SWITCH (DOLBY NR B-C SELECTOR)
SFR301.	87-021-734	SFR, 100Ω-B
302		
SFR351.	87-021-743	SFR, 22kΩ-B
352.		
501.		
502		
SFR353.	87-021-745	SFR, 47kΩ-B (Z only)
354		
SFR411	87-021-745	SFR, 47kΩ-B
412		
VR401	82-135-643	VOLUME, 50kΩ-B (BIAS FINE)
< Resistor >		
△FR601	87-029-361	3.3Ω 1/2W FUSE RESISTOR

Symbol No.	Part No.	Description
< Capacitor >		
C301.302.	87-015-951	1μF 50V ELECTROLYTIC LL
501.502		
C305.306	87-018-040	470pF CERAMIC
C309.310.	87-018-044	1000pF CERAMIC
701		
C365.366	87-018-043	820pF CERAMIC
C401.402	87-018-034	150pF CERAMIC
C411	87-014-071	3900pF 100V PP
C413	87-018-137	3300pF CERAMIC
C505.506	87-010-231	220μF 10V ELECTROLYTIC
C507.508	87-012-105	0.022μF 16V CERAMIC
C601	88-336-230	2200μF 25V ELECTROLYTIC
C602	87-010-232	220μF 16V ELECTROLYTIC
C603	87-010-049	330μF 25V ELECTROLYTIC
C606.607	89-663-815	0.01μF 25V CERAMIC
C704	87-010-139	47μF 10V ELECTROLYTIC BP
< DISPLAY CIRCUIT BOARD SECTION >		
PCB-B	*	DISPLAY CIRCUIT BOARD
D801.802.	87-027-542	LED, LN217RP (8 POINT PEAK PROGRAM METER, C-TYPE, METAL)
803.804.		
805.806.		
817.819		
D807.808.	87-027-543	LED, LN317GP (8 POINT PEAK PROGRAM METER, B-TYPE, NORMAL)
809.810.		
811.812.		
813.814.		
815.816.		
818.821		
D820	87-027-671	LED, LN417YP (CrO ₂)
D822.823	87-020-329	LED, SLP284C-51U (▶, ◀)
D824.825.	87-020-142	LED, SLP984A-51 (↔, ↷, ↻)
826		
D827	87-027-097	DIODE, 1S1555
< KEY BOARD CIRCUIT BOARD SECTION >		
PCB-C	*	KEY BOARD CIRCUIT BOARD
D831.832	87-027-732	LED, SG235D (RVS PLAY, PLAY)
D833	87-027-733	LED, SY435D (PAUSE)
D834.835	87-027-731	LED, SR535D (REC MUTE, RECORD)
D841.842.	87-027-097	DIODE, 1S1555
843.844.		
845.846.		
847.848.		
849.850		
S841	87-031-850	SLIDE SWITCH (REVERSE MODE)
S842	87-031-849	SLIDE SWITCH (TIMER)
S843.844.	87-031-863	TACT SWITCH [REW (▶▶), F.F. (◀◀), PLAY, REV PLAY, RECORD, STOP, PAUSE, REC MUTE]
845.846.		
847.848.		
849.850		
< SWITCH CIRCUIT BOARD SECTION >		
PCB-D	*	SWITCH CIRCUIT BOARD

Symbol No.	Part No.	Description
J881	★87-049-297	JACK, 6.3φ (HEADPHONES)
△S881	87-031-805	PUSH SWITCH (POWER)
< PIN JACK CIRCUIT BOARD SECTION > = EXCEPT FOR Z		
PCB-E	*	PIN JACK CIRCUIT BOARD
J1.2.3.4	★87-049-420	PIN JACK, 4P (LINE IN/REC. LINE OUT/PLAY)
< VOLUME CIRCUIT BOARD SECTION >		
PCB-F	*	VOLUME CIRCUIT BOARD
VR871	82-135-641	SLIDE VOLUME, 50kΩ-A (RECORD LEVEL)
VR872	82-135-642	SLIDE VOLUME, 150kΩ-W (REC BALANCE)
< AUTO STOP CIRCUIT BOARD SECTION >		
PCB-G	*	AUTO STOP CIRCUIT BOARD
CPL901	87-045-644	PHOTO SENSOR, NJL5141EA
< SENSOR CIRCUIT BOARD SECTION >		
PCB-H	*	SENSOR CIRCUIT BOARD
CPL902	87-045-644	PHOTO SENSOR, NJL5141EA
< TERMINAL CIRCUIT BOARD SECTION > = E, K, G, Z only		
PCB-I	82-135-607	TERMINAL CIRCUIT BOARD
< DOLBY-NR CIRCUIT BOARD SECTION >		
	87-020-132	DOLBY UNIT HA12058J (W/PCB-J)
< DIN CIRCUIT BOARD SECTION > = Z only		
PCB-K	82-160-667	DIN CIRCUIT BOARD
D21	87-020-123	DIODE, DS446
RY1	84-184-612	LEAD RELAY HA212N
J1.2.3.4.	★87-038-054	JACK PLATE A'ssy (LINE IN/REC. LINE OUT/PLAY, DIN REC/PLAY, INPUT SELECTOR)
21, S21		
< Capacitor >		
C3.4	87-018-040	470pF CERAMIC
C7.8	87-018-012	15pF CERAMIC
< MISCELLANEOUS >		
△PT951	82-135-611	POWER TRANSFORMER (H, HU, HJ only)
△PT951	82-135-612	POWER TRANSFORMER (C, U only)
△PT951	82-135-613	POWER TRANSFORMER (E, Z only)
△PT951	82-135-614	POWER TRANSFORMER (K, G only)
RPH, EH	81-508-601	HEAD RP/E HD425-RV

Symbol No.	Part No.	Description
M901	87-045-135	MOTOR, DC/EG
M902	81-505-604	REEL MOTOR
SOL901, 902, 903	81-505-603	SOLENOID, 9ME-A
△	★87-034-958	AC POWER CORD (H, HU, HJ only)
△	★87-034-578	AC POWER CORD (C, U only)
△	★82-187-797	AC POWER CORD (E, Z only)
△	★82-187-796	AC POWER CORD (K only)
△	★82-187-795	AC POWER CORD (G only)
△	★87-085-184	AC CORD BUSHING (H, HU, HJ, C, U only)
△	★87-085-185	AC CORD BUSHING (E, K, G, Z only)
S901,904, 905	81-505-607	LEAF SWITCH(REC ENA FWD, CASSETTE, REC ENA RVS)
S902,903	81-505-602	LEAF SWITCH (70 μs/120 μs, MT)
S906,907, 908	81-505-601	LEAF SWITCH(PAUSE, PLAY, DIRECTION)
△S951	87-031-853	ROTARY SWITCH (VOLTAGE SELECTOR) (H, HU, HJ only)

△ Safety component symbol

This symbol is given to important parts which serve to maintain the safety of the product, and which are made to conform to special safety specifications. Therefore, when replacing a component with this symbol, make absolutely sure that you use a designated part.

C-MOS IC handling precaution

The C-MOS IC's construction makes this part susceptible to damage by static electricity and so take sufficient care in regard to following articles.

1. Need to be put on conductive sheet, to be put in a metallic box and to be wrapped by aluminium foil for transportation and deposit.
2. To use solder iron less than 40W (less than 260°C) of power consumption for soldering. But do not overheat more than 10 second.
3. Do not perform a conductivity test with a tester, etc. Refer to the circuit voltages of each part.
4. The ICs on the electrical parts which are indicated by an C-MOS IC symbol mark (Ⓢ).

Note; Combination Circuit Board

The parts on the electrical parts list which are indicated by an asterisk (*) are supplied as one single combined circuit board. Therefore, they will not be supplied separately. If this becomes necessary, please order the entire circuit board.

Combination circuit board 82-135-601

- PCB-A 82-135-602
- PCB-B 82-135-603
- PCB-C 82-135-604
- PCB-D 82-135-605
- PCB-E 82-135-606
- PCB-F 82-135-608
- PCB-I 82-135-607

Combination circuit board 81-506-611

- PCB-G 81-506-612
- PCB-H 81-506-614

Practical Service Figure

Wow and flutter: According to DIN 45500 0.1%
Less than 0.045% (WRMS)

Pinch roller pressure: 215 ± 25g (2.1 ± 0.24N)

Take-up torque: 35 ^{+1.5}/₋₅ g-cm (3.4 ^{+1.5}/_{-0.4} g mN·m)

FF and rewind torque: 120 ~ 180g-cm (11.8 ~ 17.6mN·m)

Playback output: 540 ± 20mV
(TTA-161) [LINE OUT, DIN OUT (Z only)]

REC/PB output: +0.5 ± 1.0dB
(400Hz, 0VU, [LINE OUT, DIN OUT (Z only)]
TTA-119J)

REC/PB distortion: Less than 2.5% (NORMAL)
(400Hz)

Playback noise: Less than 3.0mV (NORMAL, 120 μs,
DOLBY-NR OFF)

REC/PB SN ratio: More than 45dB (NORMAL, DOLBY-NR
(Unweighted) OFF)
(WTD-A) More than 45dB (NORMAL, DOLBY-NR
OFF)

Erasing ratio: More than 55dB
(125Hz)

Bias frequency: 85kHz

Frequency response:

	30 ~ 60 Hz	100 ~ 650 Hz	1 kHz	2 ~ 10 kHz	13 kHz	15 kHz	16 kHz
METAL	} ⁺³ / ₋₆ dB	} ±3dB	} 0dB	} ±3dB	+3dB -4dB	+3dB -4.6dB	+3dB -5dB
CrO ₂					+3dB -4.3dB	+3dB -5dB	—
NORMAL					+3dB -5dB	—	—

Input level/impedance: LINE IN maximum input sensitivity:
50mV (over 50kΩ)
DIN maximum sensitivity (Z only):
0.1mV/kΩ (3.3kΩ)

Output level/impedance: LINE OUT standard output level: 0.4V (0VU),
suitable load impedance: over 50kΩ
DIN standard level (Z only): 0.4V (0VU)
Headphones: 8 - 32Ω

Test tape: METAL TTA-119MX
NORMAL TTA-119J
CrO₂ TTA-119G

SCHEMATIC DIAGRAM-1 (AD-R450 HB, HUB, HJB, CB, EB, KB, GB, Z models)

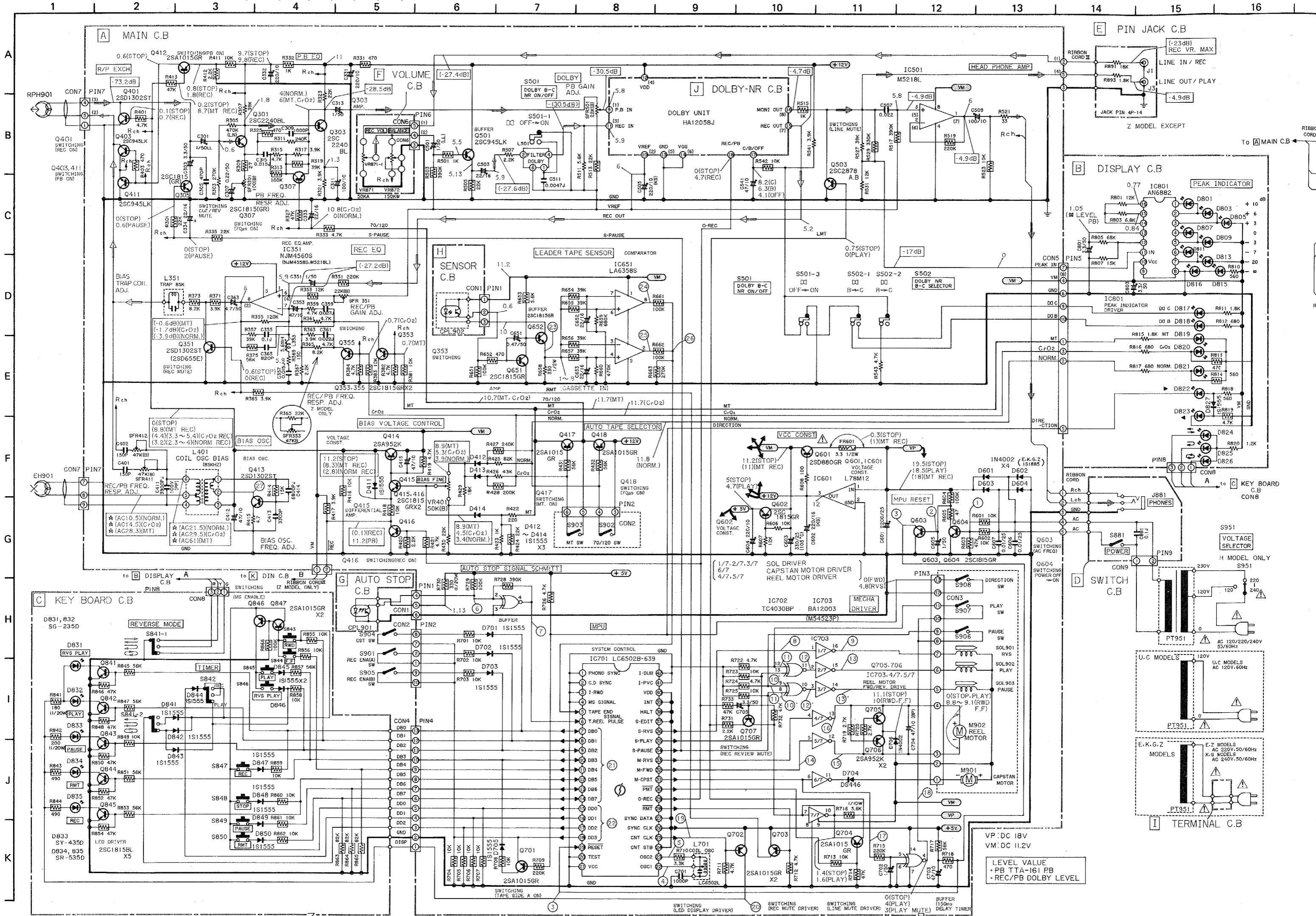

JACK C.B.

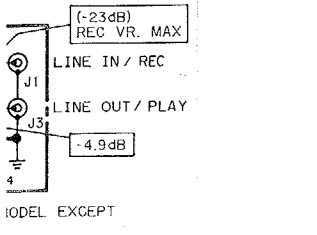

C.B.

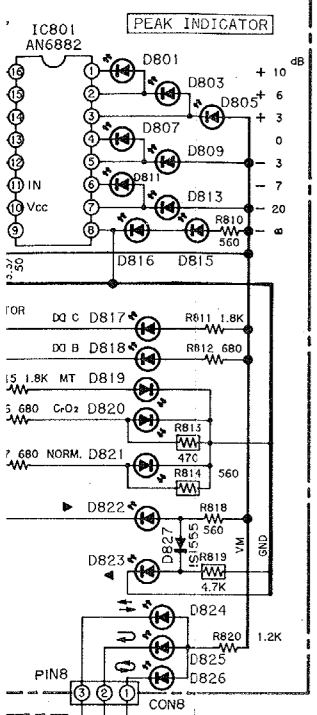

J.C. MODELS

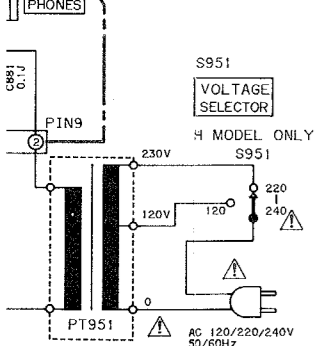

J.K.G.Z MODELS

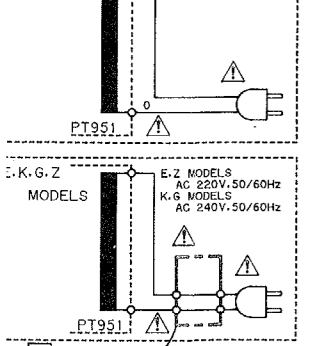

TERMINAL C.B.

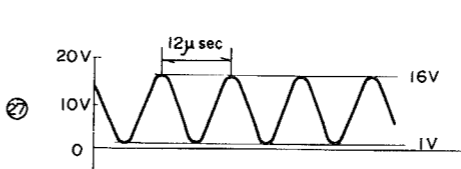
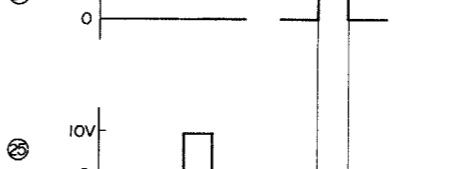
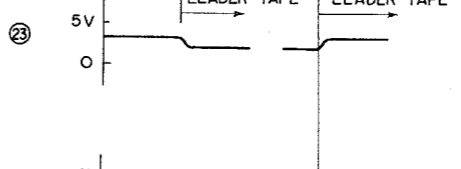
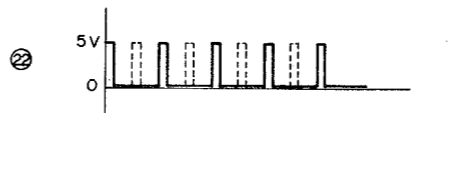
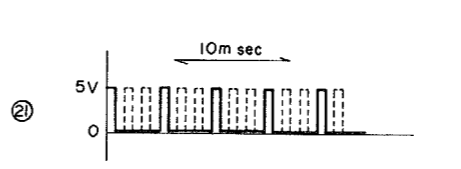
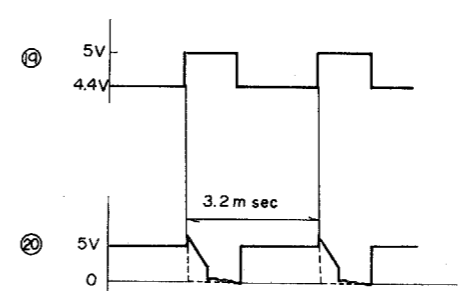
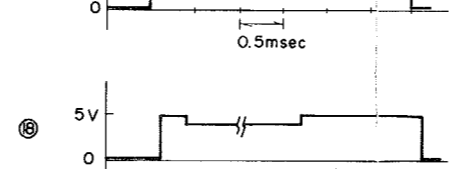
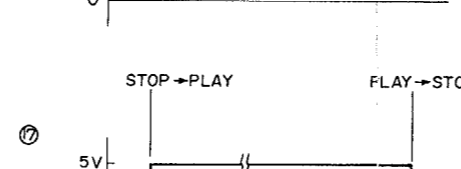
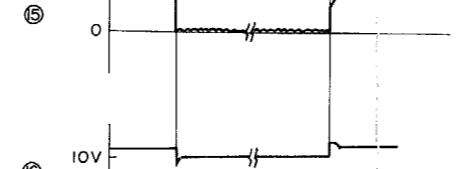
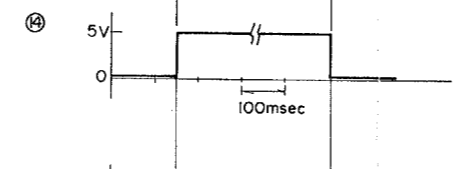
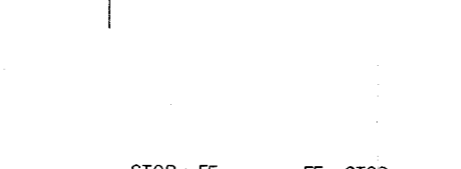
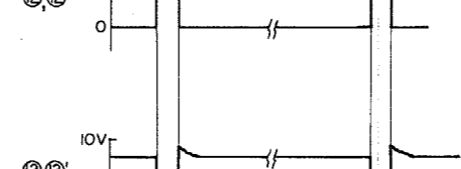
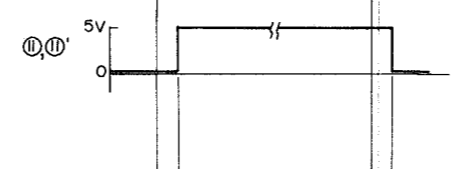
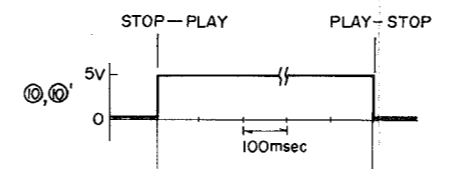
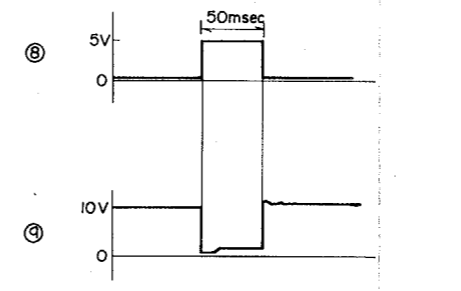
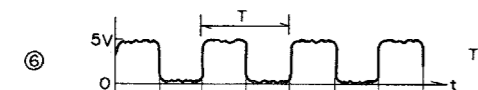
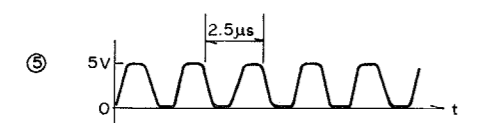
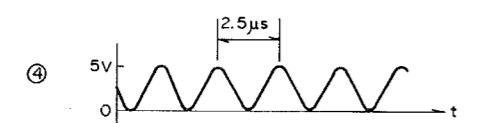
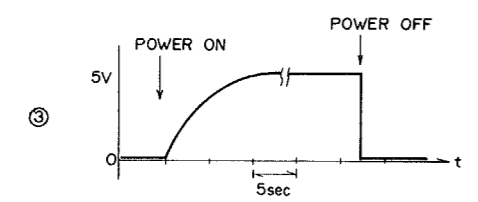
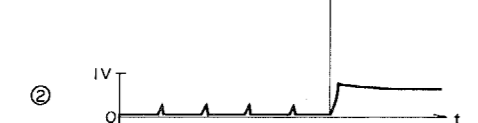
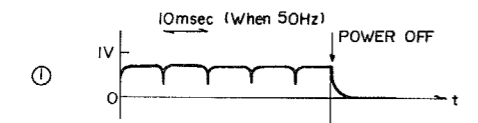
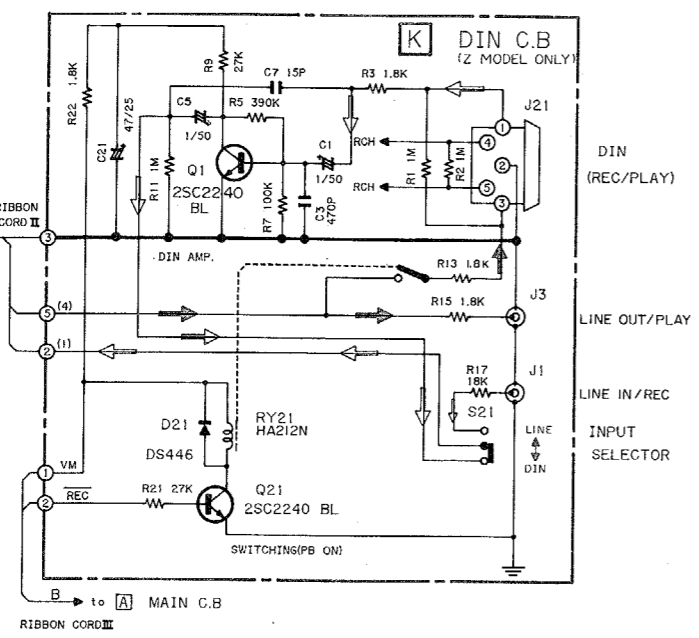

NOTES:

- 1) B (+) power supply
- 2) Signal path
- 3) Rec path
- 3) The voltage is the reference value measured with a tester (20 k-ohms/V DC) when there are no signals. But () is with recording. An asterisk (*) indicates that the value was measured with a vacuum-tube voltmeter during recording.
- 4) Resistors with no designation have a rated power of 1/8W and a tolerance of ±5%.
- 5) Capacitors with no designation have a dielectric strength of less than 50WV.
- 6) The only capacitor tolerance indicated are ±5% (J) and ±10% (K).
- 7) Ceramic capacitor symbols:
 - |—|— For temperature compensation (SL)
 - |—|— High dielectric constant system (YY)
 - |—|— High dielectric constant system (YW, YP, YZ)
 - |—|— Semiconductor ceramic
 - |—|— For temperature compensation (SH)
- 8) Explanation of symbols
 - Ⓜ Mylar capacitor
 - ⓐ Aluminum solid capacitor
 - Ⓟ Polypropylene film capacitor
 - Ⓟ Bi-polarized capacitor
 - Ⓛ Low-leakage capacitor
 - Ⓜ Printed resistor
 - Ⓜ Fuse resistor

Safety component symbol

This symbol is given to important parts which serve to maintain the safety of the product, and which are made to conform to special safety specifications. Therefore, when replacing a component with this symbol, make absolutely sure that you use a designated part.

This schematic diagram is subject to change without notice in the interests of improved performance.

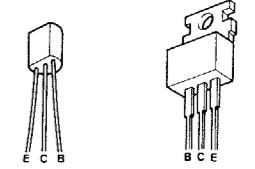

- 2SA952
- 2SA1015
- 2SC945
- 2SC1815
- 2SC2240
- 2SC2878
- 2SD1302
- 2SD880

WIRING-2 (AD-R450 HB, HUB, HJB, CB, EB, KB, GB, Z models)

1 2 3 4 5 6 7 8 9 10 11 12 13 14 15 16 17 18 19

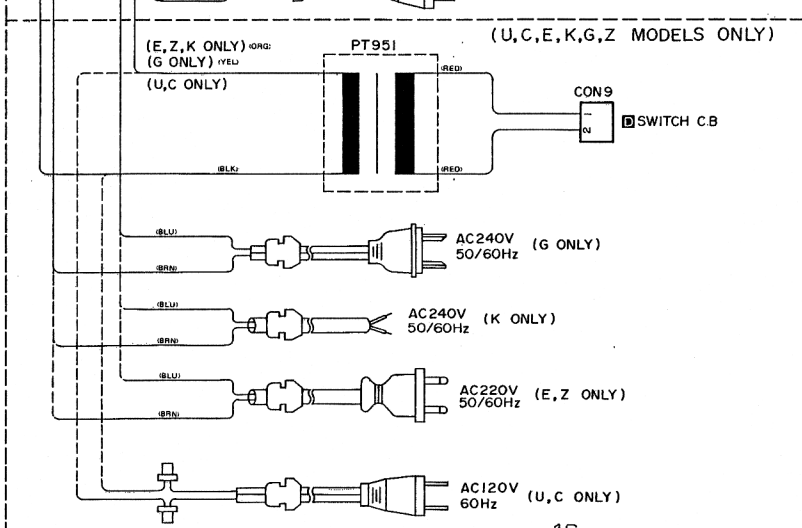
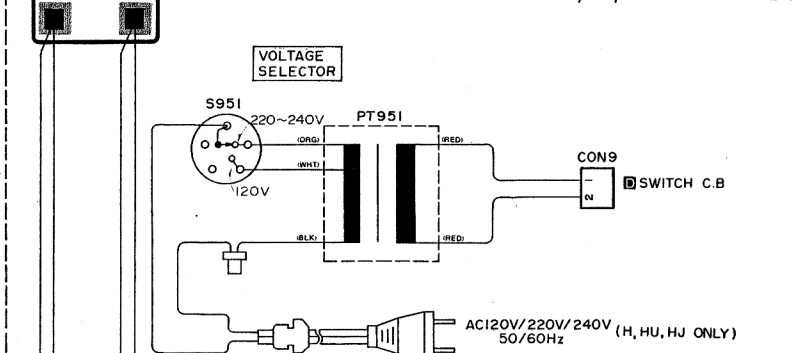
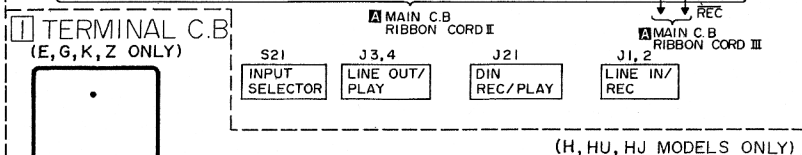
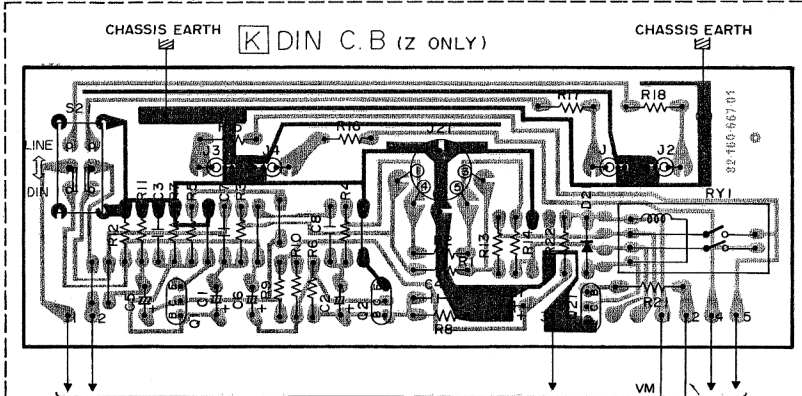
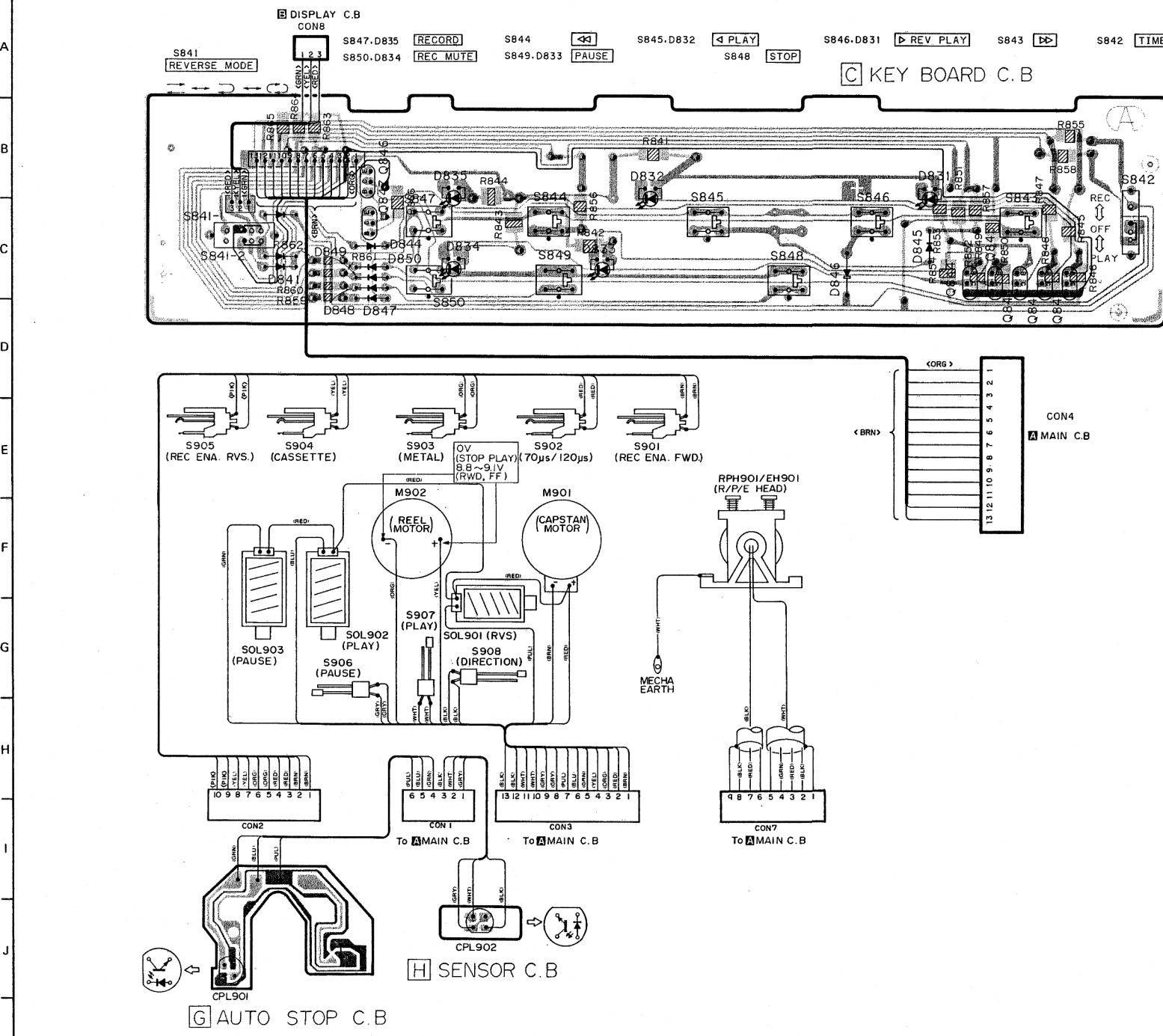

NOTES (1) Earth pattern Printed resistor pattern Others pattern
 (2) The voltage is the reference value measured with a tester (20 K ohms/V DC) when there are no signals. An asterisk (*) indicates that the value was measured with a vacuum-tube voltmeter during recording.

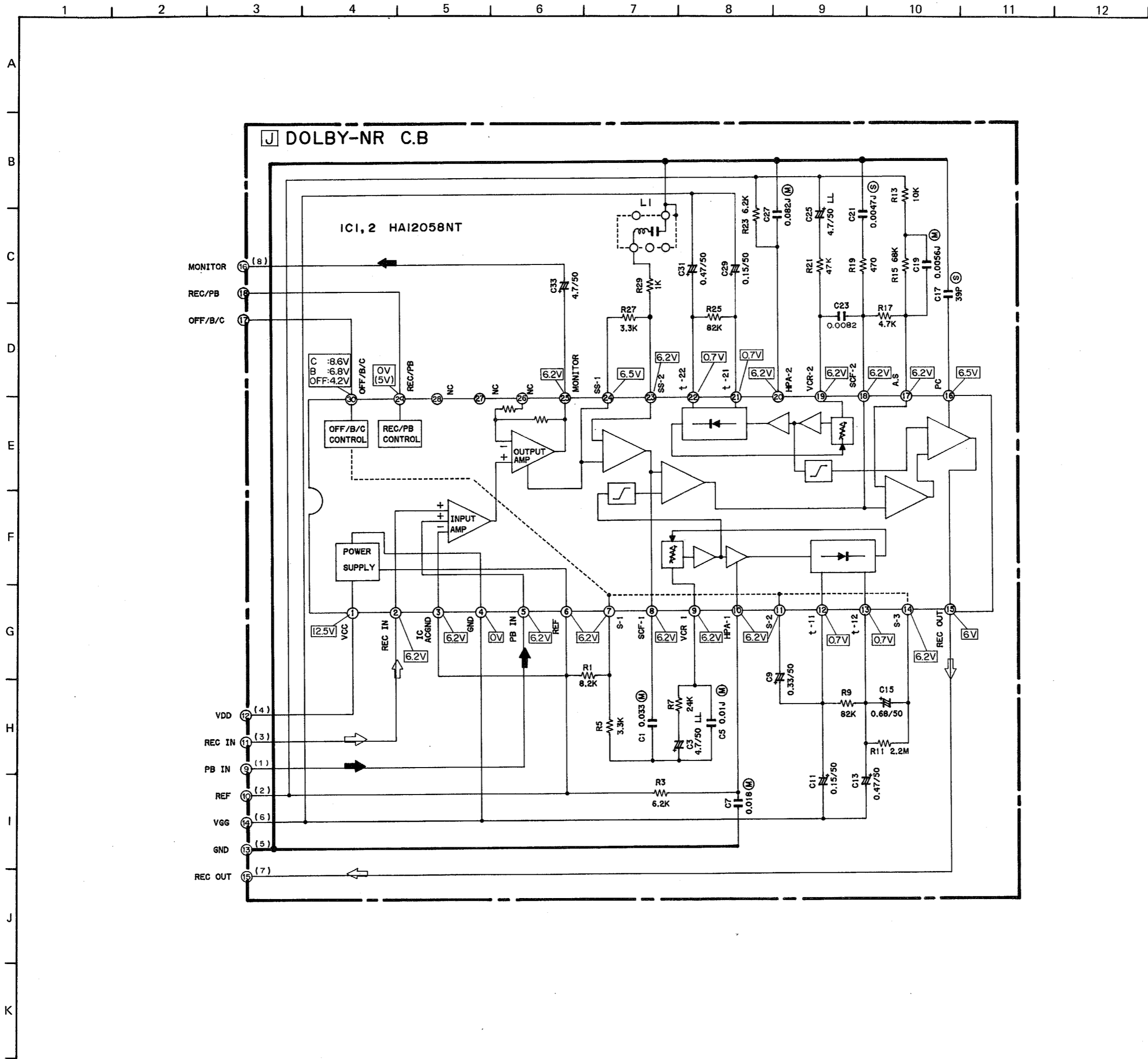

ADJUSTMENT

8. Bias Oscillation Frequency Adjustment
 Settings: • Adjustment location: L 4 0 1
 Method: Set up the REC mode, and adjust L 4 0 1 for 8.5 kHz.

6. REC/PB Frequency Response Adjustment
 Settings: • Test tape: TTA-119J
 • Test point: LINE OUT
 • Input: LINE IN: 1 kHz & 10 kHz, 33 dB
 • Dolby NR SW: OFF
 • Adjustment location: SFR 4 1 1 (Lch)
 SFR 4 1 2 (Rch)
 Method: Record the 1 kHz & 10 kHz, 33 dB signals and adjust the REC volume for 40 mV output, then play back the recorded tape and adjust so that the output difference between 1 kHz and 10 kHz is 0.5 ± 0.5 dB or less.

7. REC/PB Frequency Response Adjustment (Z MODEL ONLY)
 Settings: • Test tape: TTA-119D
 • Test point: LINE OUT
 • Input: LINE IN: 1 kHz, 10 kHz, 33 dB
 • Dolby NR SW: OFF
 • Adjustment location: SFR 3 5 3 (Lch)
 SFR 3 5 4 (Rch)
 Method: Record the 1 kHz & 10 kHz, 33 dB signals and adjust the REC volume for 40 mV output, then play back the recorded tape and adjust so that the output difference between 1 kHz and 10 kHz is 0.5 ± 0.5 dB or less.

5. REC/PB Gain Adjustment
 Settings: • Test tape: TTA-119J
 • Test point: LINE OUT
 • Input: LINE IN: 1 kHz, 33 dB
 • Dolby NR SW: OFF
 • Adjustment location: SFR 3 5 1 (Lch)
 SFR 3 5 2 (Rch)
 Method: Record the 1 kHz, 33 dB signal and adjust the REC volume for 40 mV output, then play back the recorded tape and adjust so that the output difference is $0 \sim +0.5$ dB compared with the REC mode.

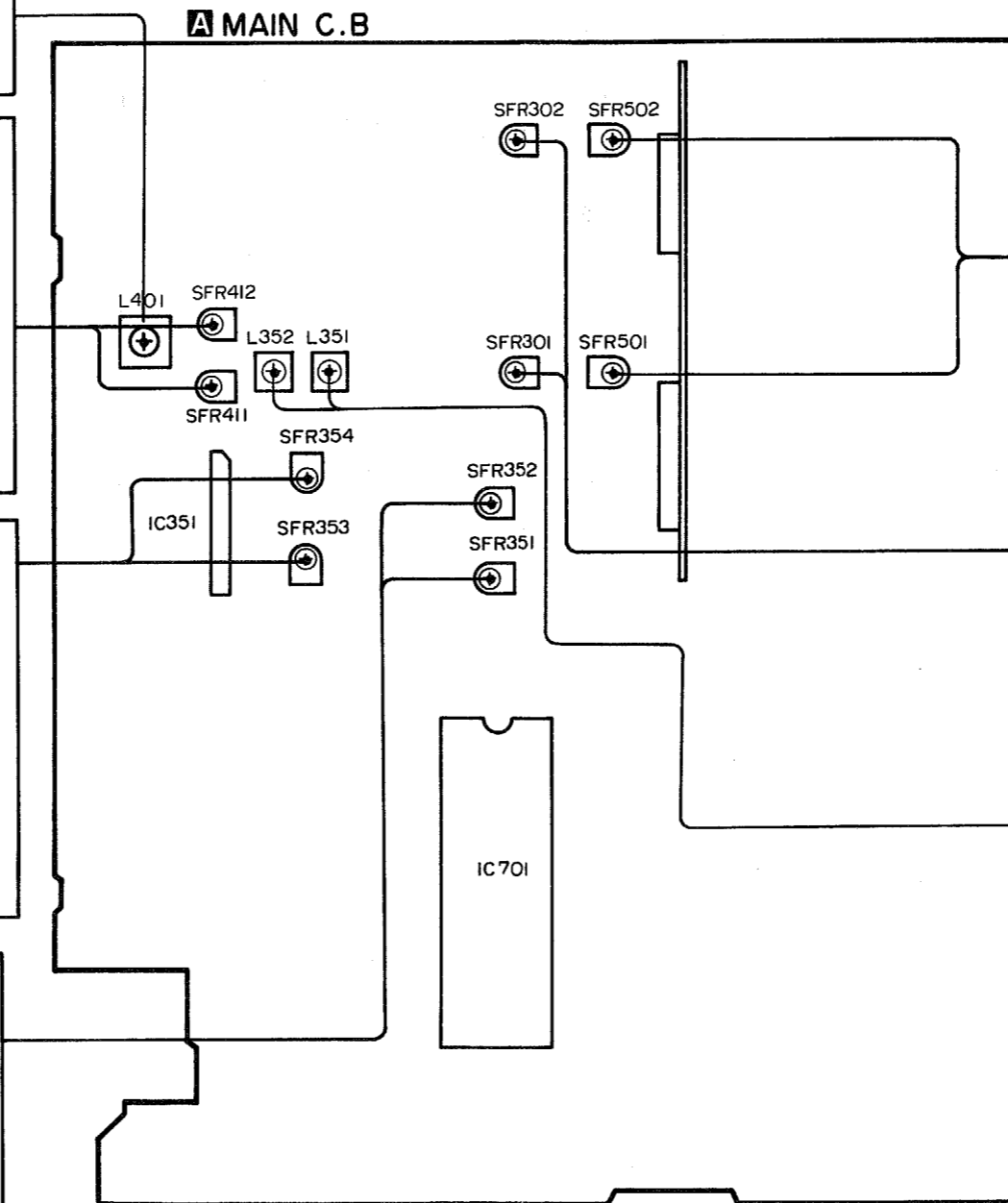

3. PB Gain Adjustment
 Settings: • Test tape: TTA-161
 • Test point: LINE OUT
 • Dolby NR SW: OFF
 • Adjustment location: SFR 5 0 1 (Lch)
 SFR 5 0 2 (Rch)
 Method: Adjust so that the output is 540 ± 10 mV.

4. PB Frequency Response Adjustment
 Settings: • Test tape: TTA-317E
 • Test point: LINE OUT
 • Dolby NR SW: OFF
 • Adjustment location: SFR 3 0 1 (Lch)
 SFR 3 0 2 (Rch)
 Method: Play back the test tape, then adjust so that the output difference between 1 kHz and 10 kHz is 0.5 ± 0.5 dB or less.

9. Bias Trap Coil Adjustment
 Settings: • Adjustment location: L 3 5 1 (Lch)
 L 3 5 2 (Rch)
 Method: Adjust L 3 5 1, 3 5 2 for minimum leakage.

EXPLODED VIEW-1

1 2 3 4 5 6 7

Ref. No.	Part No.	Description
A	87-343-065-21	UT ₁ +3-8
B	87-351-065-21	VT ₁ +3-8
C	87-351-067-21	VT ₁ +3-1.2
D	87-061-511-01	VTT+3-6
E	87-511-064-21	VFT ₁ +3-6
F	87-513-095-21	VFT ₂ +3-8
G	87-061-531-01	QTT+3-6
H	87-251-168-21	U+4-6
I	87-341-074-01	UT ₁ +2.6-8

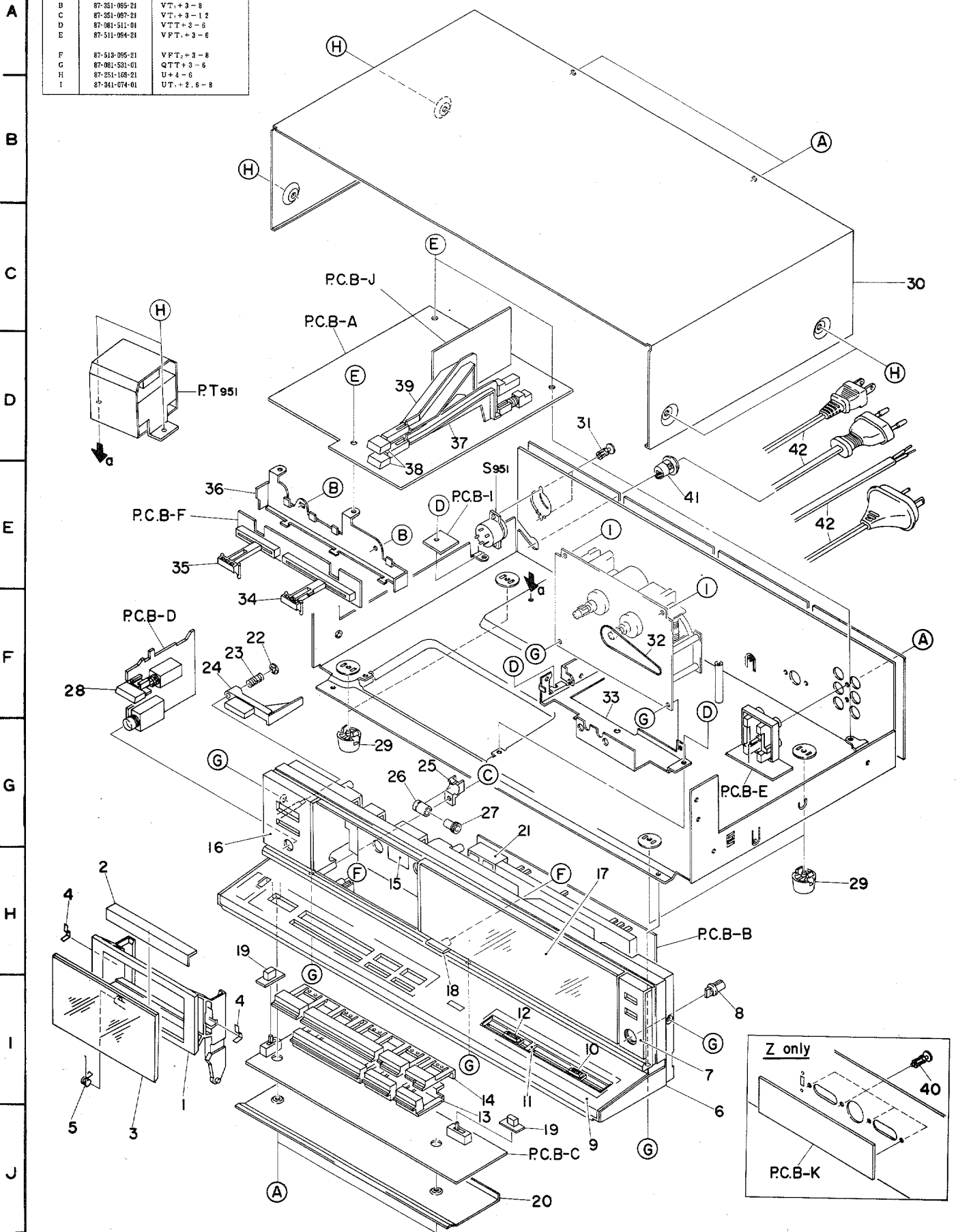

PARTS LIST

MECHANICAL PARTS LIST

● ★-mark means less required items and availabilities may be limited.

Part No. changed to	Ref. No.	Part No.	Description	Common Model	Q'ty
	1-1	82-197-008	CASSETTE BOX	FX-90	1
	1-2	★82-135-010	CASSETTE PLATE R	※	1
	1-3	★82-135-011	CASSETTE WINDOW R	※	1
	1-4	★82-192-218	P-SPRING. CASSETTE HOLDER	FX-30	2
	1-5	★82-135-210	T-SPRING. EJECT		1
	1-6	★82-135-002	FRONT CABINET	※	1
	1-7	★82-135-004	FRONT PANEL R		1
	1-8	82-192-040	KNOB B	FX-30	1
	1-9	★82-135-005	FRONT PANEL FR	※	1
	1-10	82-194-005	KNOB. REC	AD-F330	1
	1-11	★82-194-012	GUIDE. VR	AD-F330	1
	1-12	82-194-006	KNOB. BALANCE	AD-F330	1
	1-13	★82-135-007	TOUCH-KEY, STOP C	※	1
	1-14	★82-199-009	TOUCH-KEY, PLAY	AD-R550	1
	1-15	★82-648-025	LABEL. TAPE INDICATION	HS-F01	1
	1-16	★82-135-003	FRONT PANEL L	※	1
	1-17	★82-135-006	METER, WINDOW	※	1
	1-18	★87-040-172	COUNTER		1
	1-19	82-135-013	KNOB. TIMER	※	2
	1-20	★82-135-014	BOTTOM COVER	※	1
	1-21	★82-135-206	GUIDE. LED	※	1
	1-22	★87-081-903	STOPPER RING. CS-2		1
	1-23	★82-135-209	C-SPRING. EJECT		1
	1-24	82-135-008	EJECT KNOB		1
	1-25	★82-683-212	HOLDER. OIL-DAMP		1
	1-26	★82-175-207	OIL-DAMP BEARING	AD-3500	1
	1-27	★82-534-264	GEAR. OIL-DAMP		1
	1-28	82-188-012	KNOB. POWER		1
	1-29	★87-055-055	FOOT		4
	1-30	★82-199-012	STEEL CABINET	AD-R550	1
	1-31	★87-085-083	NYLON RIVET 3-5.5 (HB. HUB. HJB only)		2
	1-32	★82-542-209	BELT. COUNTER		1
	1-33	★82-197-203	HOLDER. MECHANISM	FX-90	1
	1-34	★82-135-218	SLIDE VOLUME R	※	1
	1-35	★82-135-208	SLIDE VOLUME L	※	1
	1-36	★82-135-207	HOLDER. CIRCUIT BOARD	※	1
	1-37	★82-135-205	ROD, B/C	※	1
	1-38	★82-135-012	PUSH-BUTTON. DOLBY	※	2
	1-39	82-135-204	ROD, ON/OFF	※	1
	1-40	★87-085-102	NYLON RIVET 3.5-5.5 (Z only)		4
	1-41	★87-085-184	CORD BUSHING (HB. HUB. HJB. CB only)		1
		★87-085-185	CORD BUSHING (EB. KB. GB. Z only)		1
	1-42	★87-034-958	AC POWER CORD (HB. HUB. HJB only)		1
		★87-034-578	AC POWER CORD (CB only)		1
		★82-187-797	AC POWER CORD (EB. Z only)	AD-3150	1
		★82-187-796	AC POWER CORD (KB only)	AD-3150	1
		★82-187-795	AC POWER CORD (GB only)	AD-3150	1

EXPLODED VIEW-2

1 2 3 4 5 6 7

Ref. No.	Part No.	Description
A	87-081-954-01	V+1.6-3
B	87-081-503-01	VTT+2.6-8
C	87-341-035-21	UT.+2-6
D	87-081-808-01	PW1.7-3.5-0.25
E	87-067-105-01	PW3.4-8-0.5

A
B
C
D
E
F
G
H
I
J

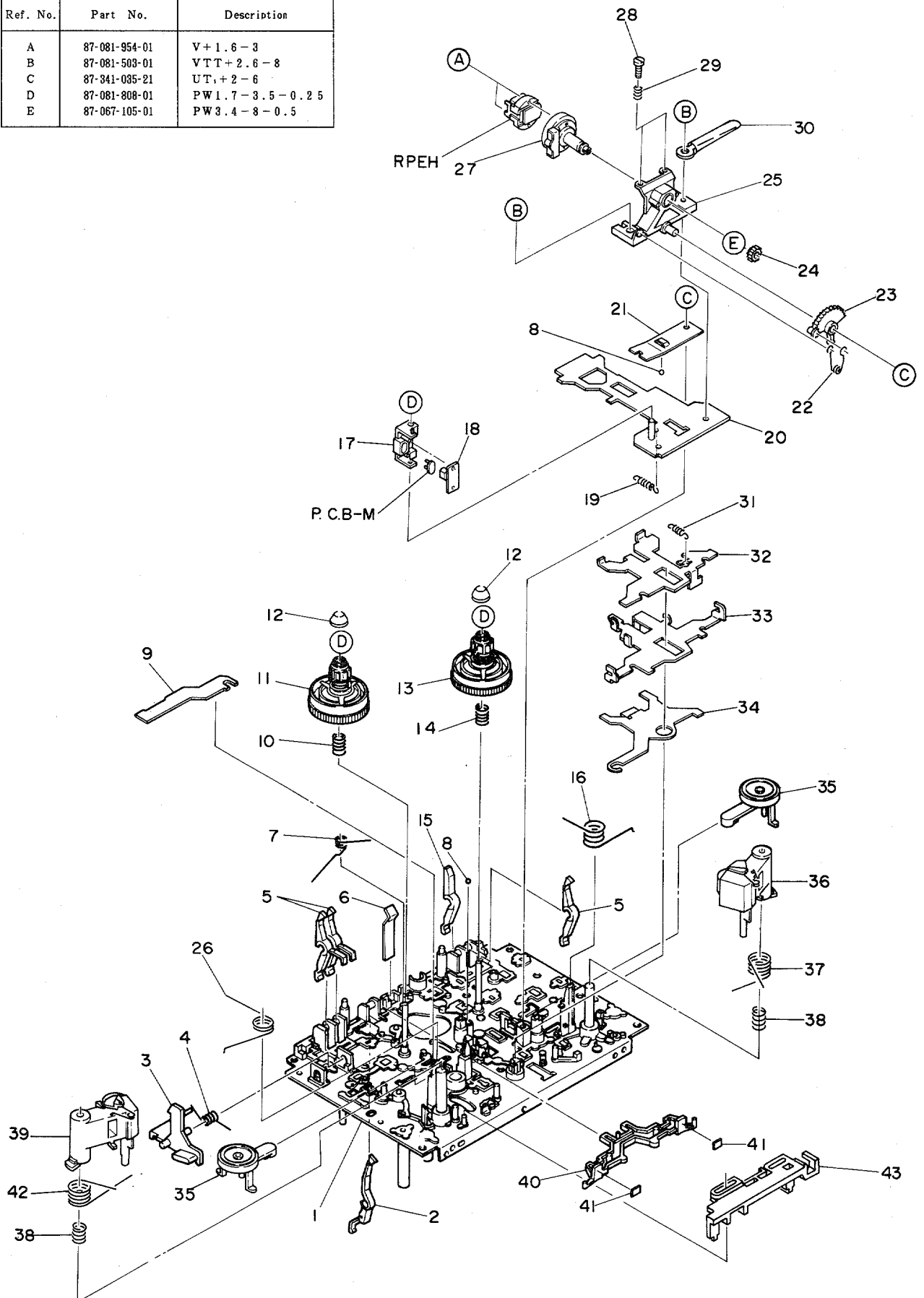

Part No. changed to	Ref. No.	Part No.	Description	Common Model	Q'ty
	2-1	★81-506-201	OUTSERT CHASSIS Ass'y		1
	2-2	★81-505-242	LEVER, METAL		1
	2-3	★81-505-239	EJECT, LEVER		1
	2-4	★81-505-273	T-SPRING, LID LOCK		1
	2-5	★81-505-241	REC BLOCKING LEVER		3
	2-6	★81-505-260	P-SPRING, CASSETTE HOLDER		1
	2-7	★81-505-268	T-SPRING, SLIDE BLAKE		1
	2-8	★87-073-005	STEEL BALL		2
	2-9	★81-505-238	BLOCKING PLATE, EJECT		1
	2-10	★81-505-274	C-SPRING, SUPPLY REEL PLATFORM		1
	2-11	★81-506-239	SUPPLY REEL PLATFORM RP Ass'y		1
	2-12	★82-303-398	CAP. TAKE-UP REEL PLATFORM		2
	2-13	★81-506-240	TAKE-UP REEL PLATFORM FP Ass'y		1
	2-14	★81-506-227	C-SPRING, REEL PLATFORM		1
	2-15	★81-505-240	LEVER, CASSETTE SENSOR		1
	2-16	★81-505-270	T-SPRING, IDLER LEVER		1
	2-17	★81-506-236	GUIDE, TAPE		1
	2-18	★81-506-274	GUIDE, LIGHT		1
	2-19	★81-505-265	E-SPRING, ACTUATING CHASSIS		1
	2-20	81-506-238	ACTUATING CHASSIS Ass'y		1
	2-21	★81-507-224	P-SPRING, ACTUATING CHASSIS		1
	2-22	★81-506-348	T-SPRING, SEGMENT		1
	2-23	★81-506-219	GEAR, SEGMENT		1
	2-24	★81-506-237	GEAR, HEAD HOUSING		1
	2-25	★81-506-319	HEAD BASE Ass'y		1
	2-26	★81-506-220	T-SPRING, IDLER LEVER R		1
	2-27	★81-506-208	HEAD HOUSING Ass'y		1
	2-28	★81-506-230	ADJUST SCREW, AZIMUTH		2
	2-29	81-506-293	C-SPRING, AZIMUTH		2
	2-30	★87-038-056	WIRE BINDER		1
	2-31	★81-505-266	E-SPRING, PAUSE PLATE		1
	2-32	★81-506-301	PLATE, PAUSE		1
	2-33	★81-506-281	PLATE, PINCH LEVER R		1
	2-34	★81-506-203	SELECT LEVER, PINCH ROLLER		1
	2-35	★81-505-344	IDLER LEVER Ass'y		2
	2-36	★81-506-275	PINCH LEVER FG Ass'y		1
	2-37	★81-506-222	T-SPRING, PINCH FG		1
	2-38	81-506-311	C-SPRING		1
	2-39	★81-506-276	PINCH LEVER RG Ass'y		1
	2-40	★81-505-236	LEVER, SLIDE BRAKE		1
	2-41	81-505-237	FELT		2
	2-42	★81-506-223	T-SPRING, PINCH RG		1
	2-43	★81-506-215	SLIDE LEVER, HEAD SELECT		1

EXPLODED VIEW-3

1 2 3 4 5 6 7

Ref. No.	Part No.	Description
A	87-261-075-21	V+2.6-1.0
B	87-351-034-21	VT,+2-5
C	81-505-341-01	VFT+2.6-31.5
D	87-512-074-21	VFT ₂ +2.6-8
E	87-351-034-21	PW2.6-8-0.13
F	82-416-358-01	PW2.5-6-0.25

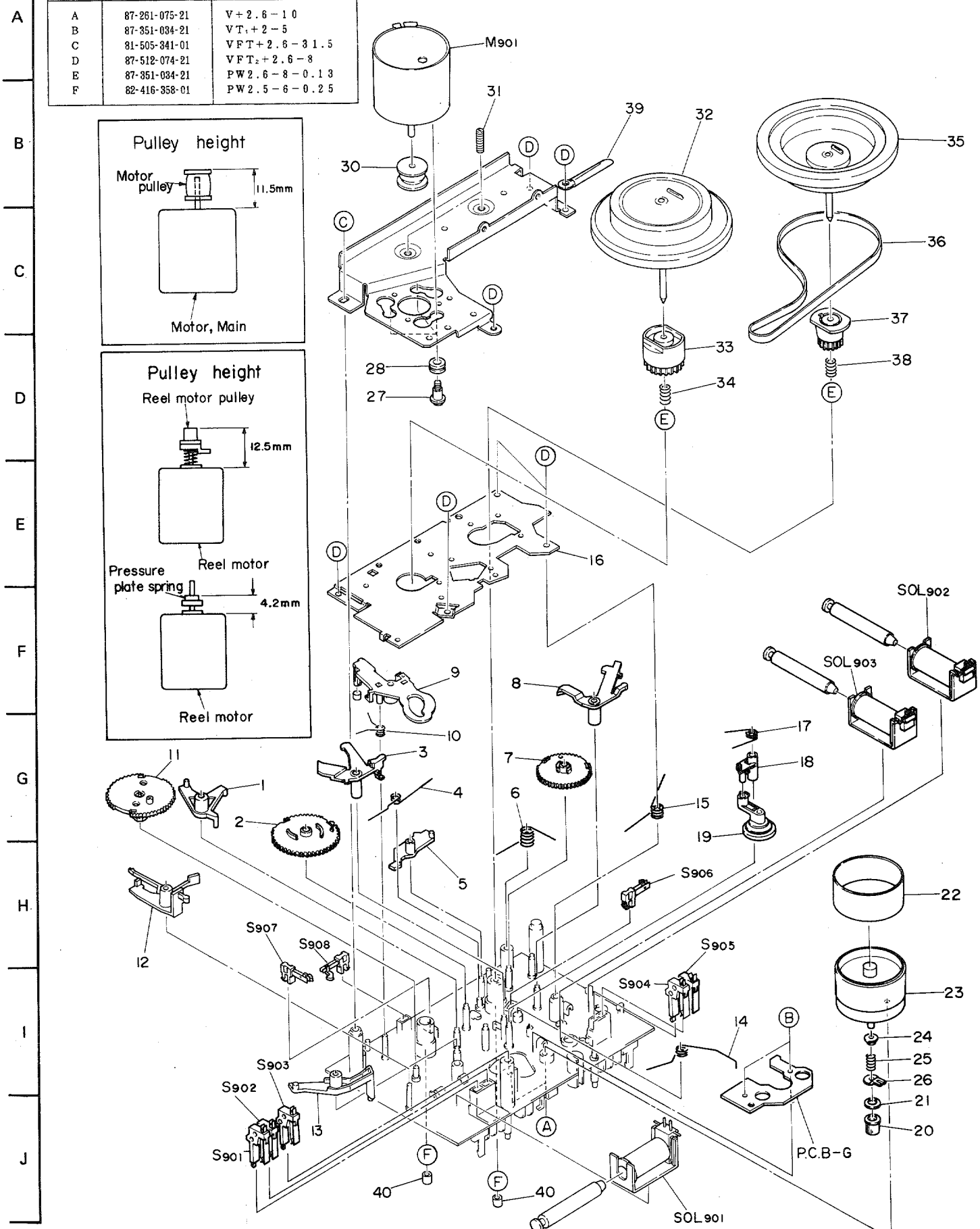

Part No. changed to	Ref. No.	Part No.	Description	Common Model	Q'ty
	3-1	★81-505-230	PLAY LEVER		1
	3-2	★81-505-234	GEAR, PLAY CAM		1
	3-3	★81-505-231	TRIGGER LEVER, PLAY		1
	3-4	★81-505-272	T-SPRING, CAM		1
	3-5	★81-505-232	PAUSE LEVER		1
	3-6	★81-505-283	T-SPRING, PAUSE LEVER		1
	3-7	★81-505-235	GEAR, PAUSE CAM		1
	3-8	★81-505-233	TRIGGER LEVER, PAUSE		1
	3-9	★81-506-214	REVERSE LEVER		1
	3-10	★81-506-221	T-SPRING, REVERSE LEVER		1
	3-11	★81-506-241	GEAR, REVERSE		1
	3-12	★81-506-242	TRIGGER LEVER, REVERSE		1
	3-13	★81-506-216	LEVER, ACTUATING CHASSIS		1
	3-14	★81-505-269	T-SPRING, PINCH PLATE		1
	3-15	★81-505-271	T-SPRING, TRIGGER LEVER		1
	3-16	★81-505-204	MECHANISM CHASSIS B		1
	3-17	★81-505-282	T-SPRING, FR IDLER		1
	3-18	★81-505-254	IDLER LEVER FR A		1
	3-19	★81-505-301	FR IDLER Ass'y		1
	3-20~26	09-047-198	REEL MOTOR Ass'y		1
	3-27	★87-081-483	MOTOR SCREW, M2.6		3
	3-28	★87-087-029	RUBBER CUSHION		3
	3-29	★81-506-202	HOLDER, MOTOR		1
	3-30	★82-565-334	MOTOR PULLEY		1
	3-31	★82-565-373	THRUST SCREW		2
	3-32	★81-506-287	FLYWHEEL RB Ass'y		1
	3-33	★81-506-243	GEAR, FLYWHEEL		1
	3-34	★81-506-228	C-SPRING, FLYWHEEL R		1
	3-35	★81-506-205	FLYWHEEL F Ass'y		1
	3-36	81-506-229	RUBBER BELT, 3H		1
	3-37	★81-505-225	GEAR, FLYWHEEL		1
	3-38	★81-505-261	C-SPRING, FLYWHEEL F		1
	3-39	★87-038-039	WIRE BINDER		1
	3-40	81-505-246	RUBBER, DRIVE		2

■ ACCESSORIES/PACKAGE LIST

Part No. changed to	Ref. No.	Part No.	Description	Common Model	Q'ty
	1	82-135-901	BOOKLET, INSTRUCTION	※	1
	2	★87-049-137	SIEMENS PLUG (H, HJ only)		1
	3	★87-034-978	CONNECTION CORD CW-254BSK		2
	4	82-135-851	BOX, GIFT (H, HU, C, K, G, Z only)	※	1
		82-135-854	BOX, GIFT (HJ, E only)	※	1

AIWA Co., Ltd. Tokyo Japan